

Article number: 07148050001

Description: Universal joint single 0.148.050.001
S=145 X= Bore with keyway

Measures

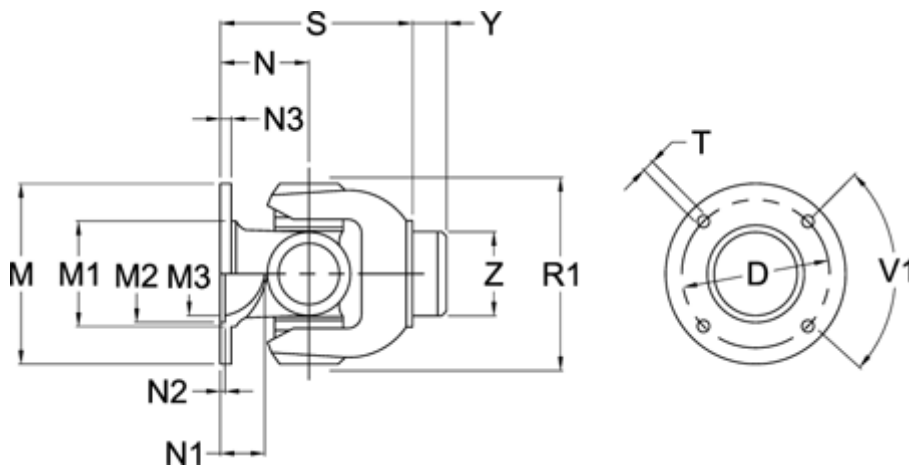

D	= 130 +0,1	N2	= 3 +0,5	Z = 72.25
Flange diameter M	= 150	N3	= 10	
M1	= 104	Number og Flangeholes	= 8	
M2	= 90	R1	= 138	
M3	= 76	S min	= 145	
Max. Bending Angle degrees	= 20	T	= 12 B12	
N	= 65	V1 degrees	= 45	
N1	= 32	Y	= 25	